

DO NOT SCALE

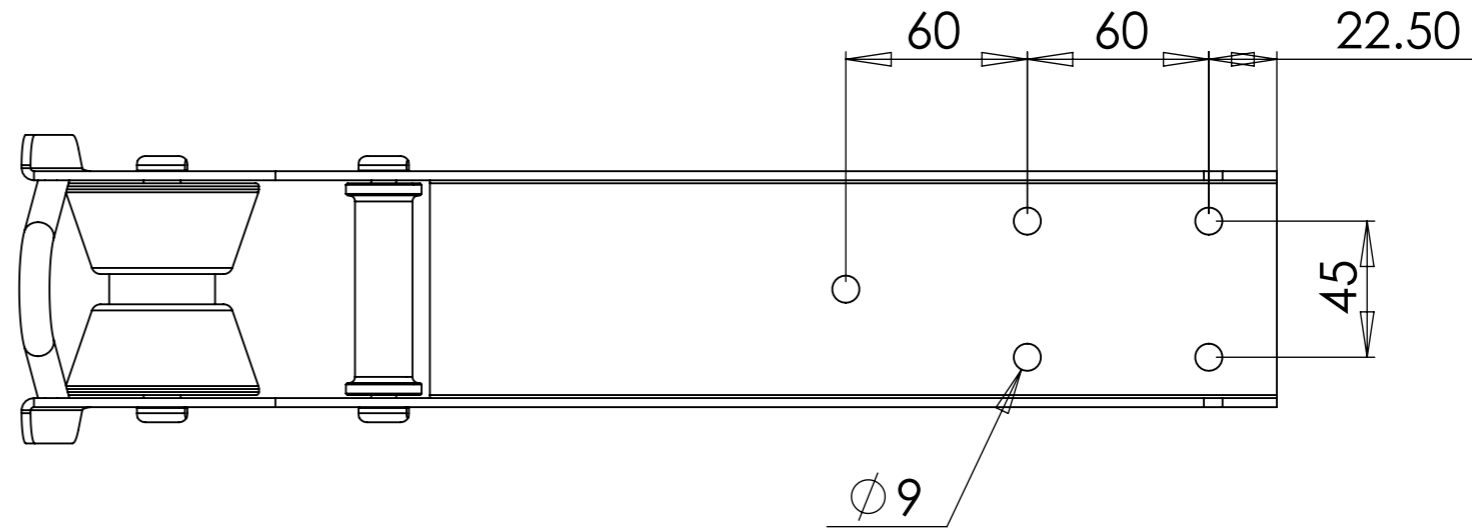
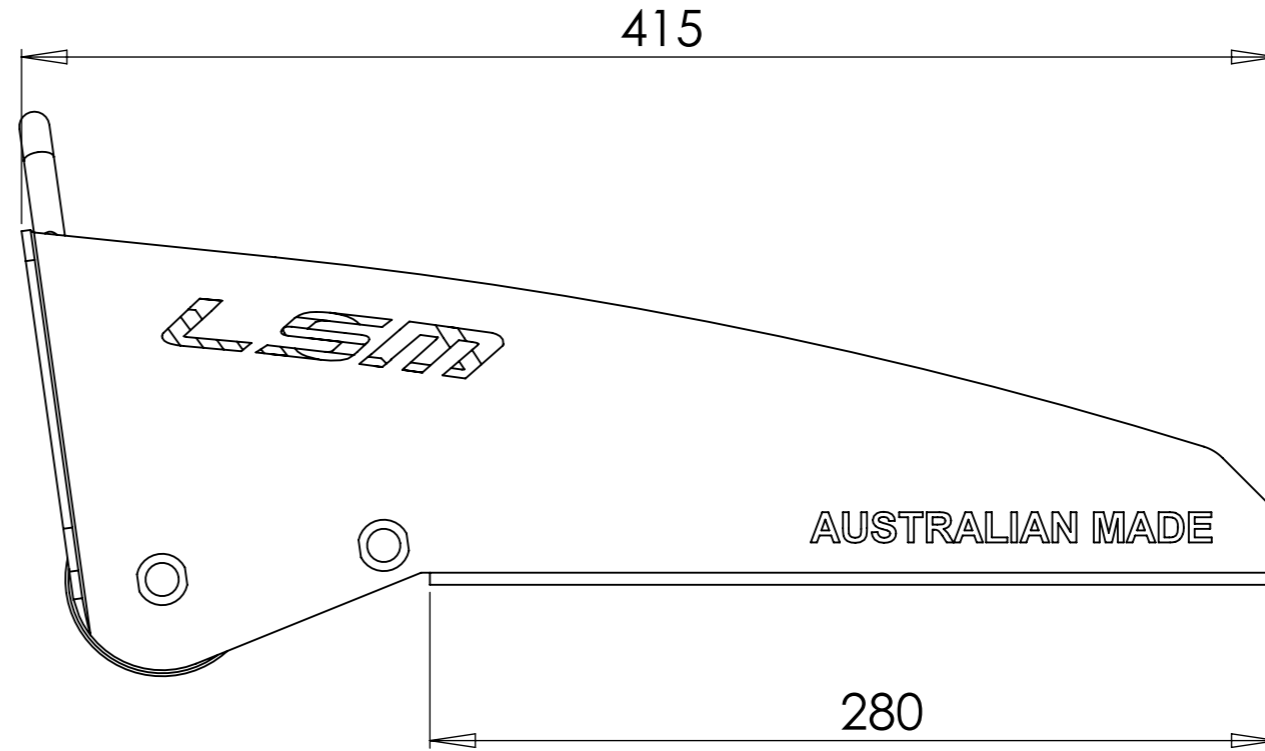
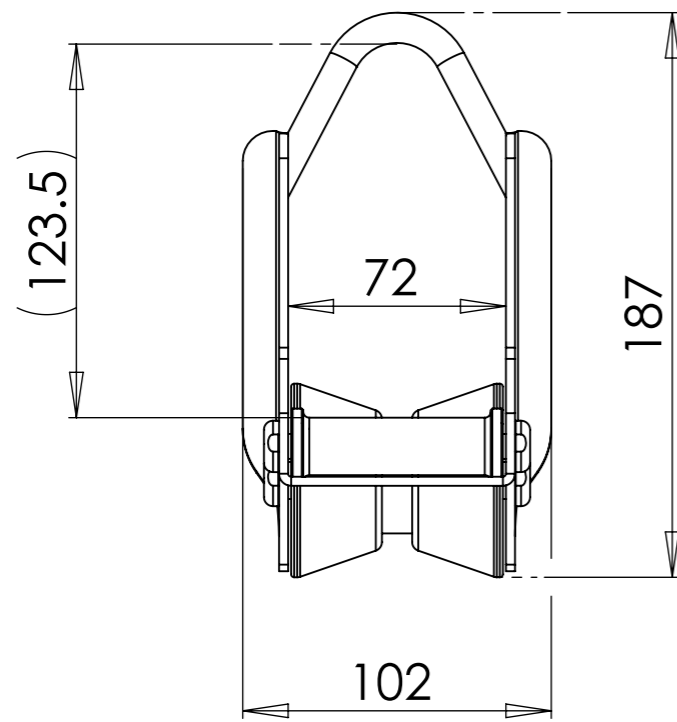

This document and its contents are the property of Lone Star Marine, they are protected by design registration and copyright, any form of disclosure to any third party is strictly prohibited unless written permission is given from Lone Star Marine.

UNLESS OTHERWISE SPECIFIED: DIMENSIONS ARE IN MILLIMETERS SURFACE FINISH: TOLERANCES: LINEAR: ANGULAR:		FINISH:		DEBUR AND BREAK SHARP EDGES		DO NOT SCALE DRAWING		REVISION	
DRAWN		NAME		SIGNATURE		DATE		TITLE:	
CHK'D		CHRIS				17-8-2015			
APPV'D									
MFG									
Q.A								MATERIAL:	
								DWG NO. CX-415	
								A3	
								WEIGHT:	
								SCALE:1:5	
								SHEET 1 OF 1	